

Highlights 2016

Visit our stand 2 B05
Big 5 Saudi



www.elkoep.com

iNELS® Smart Home
& Building Solutions



WIRELESS

installation



BUS

installation



AUDIO-VIDEO

distribution & management

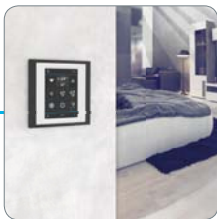

HOSPITALITY

Guest Room
Management
system



BMS

Building
management
system



3rd PARTY

integration & system

NEWS

3rd system integration

Building
management system

Guest room
management system

BUS & Wireless
integration

Home appliances
Miele under
iNELS control

Onvif IP cameras
integrated

Control your iNELS
through Smartwatch app

Smart Kits as starter
to the smart word

Energy monitoring
and management

www.inels.com

3rd party system integration

The INELS solution provides the user with a single driver for all technology in the home or building. This gives the customer the option of central and remote monitoring for the entire system. We are able to offer a truly comprehensive solution, integrating more and more protocols, devices and systems.

iMM and Connection Server now support communication with up to eight central units with the iNELS protocol ELKONET. With the combination of topologies and protocols for integration of digital lighting control we can control DALI and DMX eg. Large lighting systems, with up to four thousand lights.



Visit our stand 2 B05

ELKO EP Holding, SE,
Holesov-Vsetuly, Czech republic





Building management system

The central unit CU3 has a universal ASCII protocol, which is able to integrate iNELS into Building Management Systems. The protocol is open and completely flexible depending on the system integrator, with which the iNELS system interconnects. Within iNELS BMS is contained the ideal solution for the control of lighting, shading, appliances or temperature.



DALI / DMX

We have developed the EMDC-64M unit - a gateway between the iNELS system and digital protocols for lighting control of DALI and DMX. Using iNELS it makes it now possible to drive up to four thousand lamps divided into individually customizable zones and controlled modes depending on the time and intensity of sunshine, which together applied effectively reduce energy costs.



A/C Control integration

The CoolMasterNet device integration enables integration with iNELS using the universal protocol control of the main representatives of HVAC solutions, such as. Daikin, Gree, LG, Mitsubishi, Panasonic, Samsung and Fujitsu.



BUS&RF integration

The CU3-02M central unit has the option to control RF Control wireless receivers. This makes it possible to fully combine bus and a wireless system and benefit from it.



PHONE
+ 420 800 100 671



E-MAIL
export@elkoep.com



www.elkoep.com
www.inels.com

Guest room management system (GRMS)

iNELS in the form of GRMS (Guest Room Management System) enables not only control of lighting, air-conditioning or room access, but also control of music or television. All of this occurs from the central touch panel in designs of clear plastic, the natural materials

wood, metal, stone or luxurious glass touch panels. A standard service we offer customers is customization – a description of symbols applied by laser onto plastic or glass controllers based on specification.

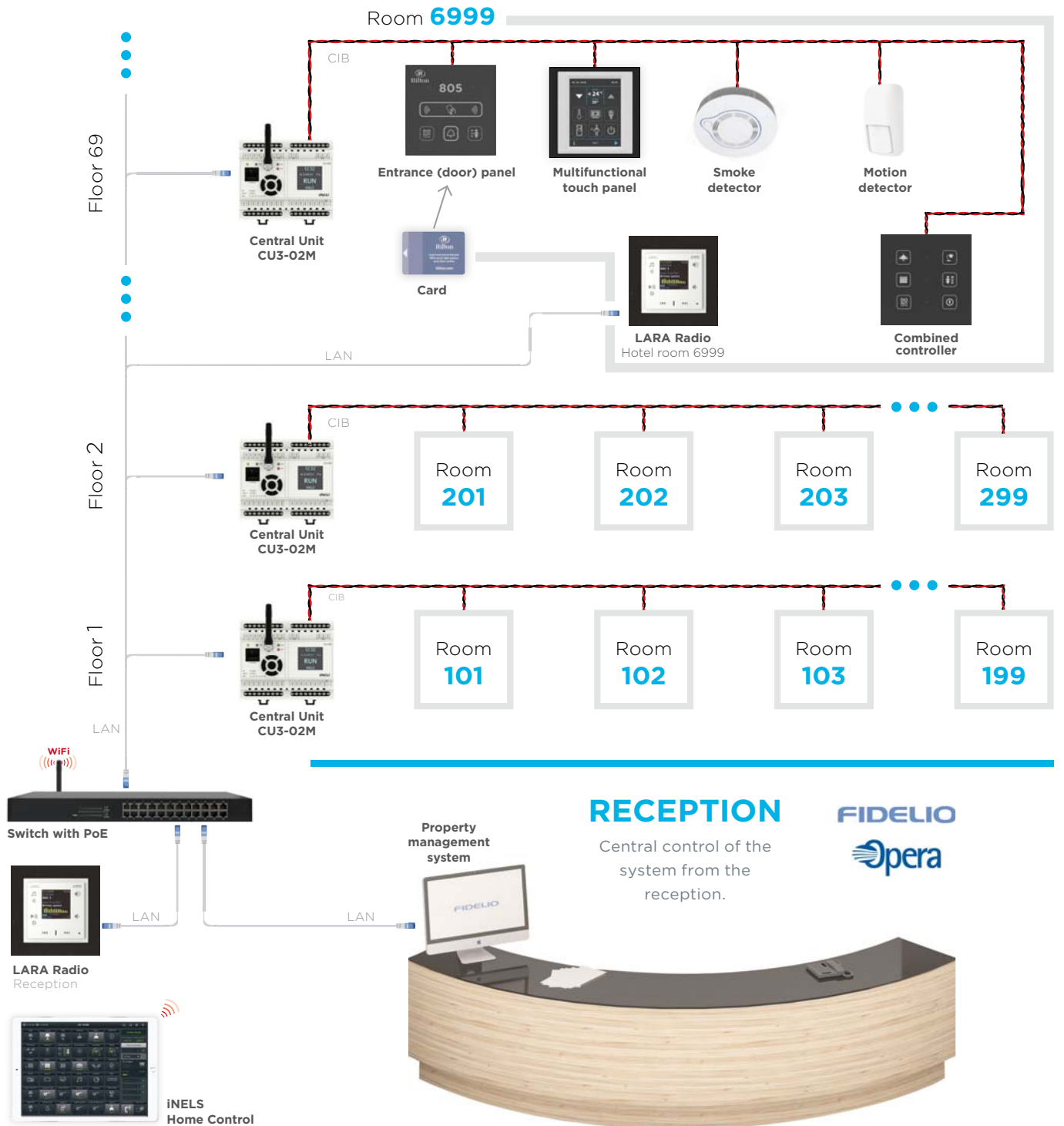

Visit our stand 2 B05

ELKO EP Holding, SE,
Holesov-Vsetuly, Czech republic





MIELE@home 2.0

Through the XGW 3000 gateway and the iHC and iMM applications the user acquires control of Miele appliances from one place - your phone, tablet or TV. It is possible to monitor remotely e.g. washing machine, dryer, oven, dishwasher and coffee maker.



LARA Radio&Music

Can you imagine that in just a switch, radio and MP3s can play, or that through this switch, you can talk to your roommates or a visitor at the door? Yes, it is possible. We were able to incorporate all these functions into a single device the size of a switch.

lara.inels.com



Onvif IP cameras

With the integration of the universal ONVIF protocol the user is not limited in selecting the brand of IP cameras and may choose any of the 300 manufacturers whose cameras are compatible with this protocol. By applying iHC it is easy to keep track of events.



VoIP solutions

VoIP solutions increase the sense of security as the user using video and audio transmission can simply verify who is standing at the entrance to the building. We have integrated universal SIP INELS and thus it can be used with a wide range of IP intercoms.



PHONE
+ 420 800 100 671



E-MAIL
export@elkoep.com



www.elkoep.com
www.inels.com



Smartwatch iNELS app

It is a well-known fact that ELKO EP is not afraid to invest in new trends and technologies. One other direction that we are going, is the application called Smart watch or Smartwatch.

The application that combines the Smart Watch and Smart Home is called iNELS HOME CONTROL. Normally a customer's smartphone is able to connect via Bluetooth with their smart watches. The owner can control the lighting in the house, switch appliances, blinds or regulate the heating while fully engaged in other important activities. The application is designed for watches supporting the Android operating system.



iNELS Home Control

The iNELS intelligent electrical installation system controls everything from heating regulation and air-conditioning, lighting, blinds and other appliances to securing your home and protecting your property. With iNELS, you always keep an eye on your home. Anytime, wherever... All technologies are controlled directly from this application, whether you are connected in a home network (LAN) or you are using mobile data while on the go.

Available on:



Visit our stand 2 B05

ELKO EP Holding, SE,
Holesov-Vsetuly, Czech republic



Smart Kits

Do Your Smart Home Yourself

It's the revolution in housing. We introduced new product kits to the market (smart and wireless), through which each house can easily become a smart house. The Smart Kit is set as a starter package for Smart Homes. The actual implementation will entertain every playful family!

Usage brings modernization, comfort and significant savings that can in many cases add up to 30% per year. Kits are divided by Theme, for example, remote control of heating, lighting, music player and Internet radio.



Game of lights

Wireless kit for controlling lights via your smartphone.



Remote heating

Wireless kit to control heating via your smartphone.



Heating with saving

Wireless kit to control heating via RF Touch unit.



Easy heat regulation

Wireless kit for wireless control of electric heating.



Radio & music in switch

Wireless kit for controlling music, which perfectly fits in your home's interior.



One controller for all

Wireless kit for controlling IR devices via a smartphone.



Your house under the thumb

Wireless kit for controlling household via smartphone.



www.inelskits.com



PHONE
+ 420 800 100 671



E-MAIL
export@elkoep.com



www.elkoep.com
www.inels.com

Energy management



Wired solution (BUS) for larger buildings



day / month / year



day / month / year

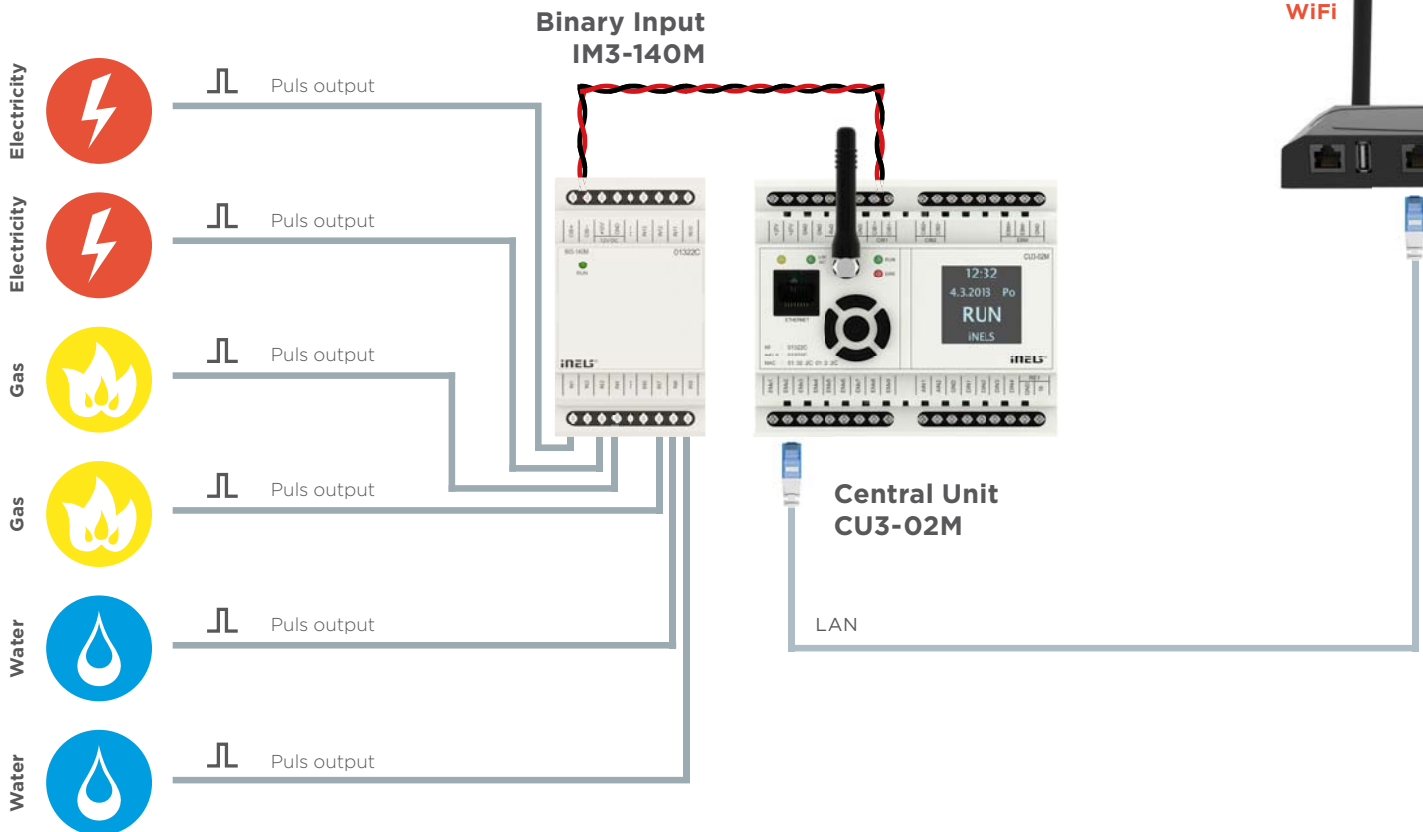
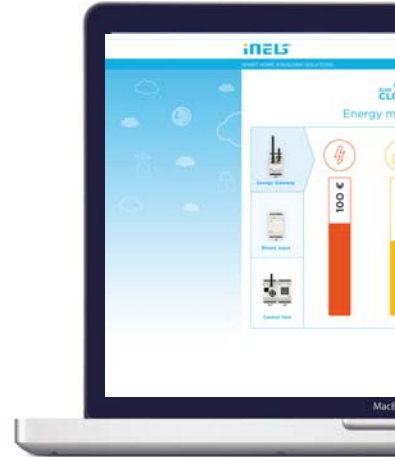

•
• ... up to 14 outputs
• (more IM3-140M input moduls should be used)

Visit our stand 2 B05

ELKO EP Holding, SE,
Holesov-Vsetuly, Czech republic



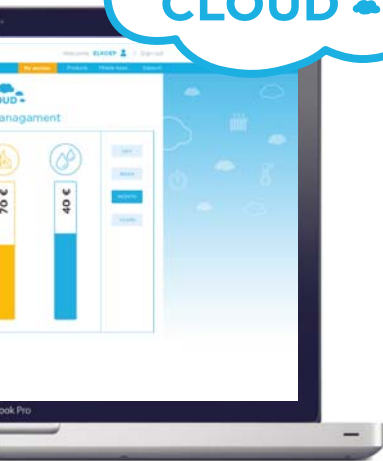

Wireless solution (RF) for existing apartments and houses

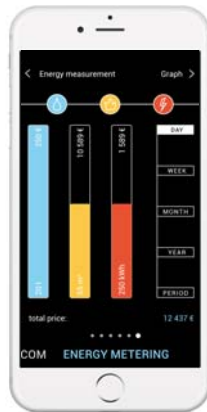

day / month / year

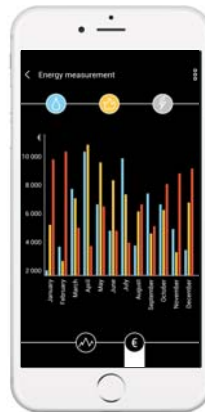

day / month / year

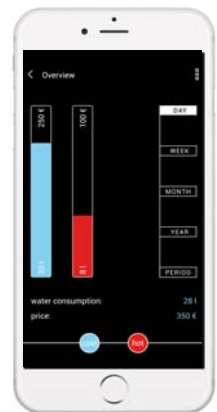

day / month / year

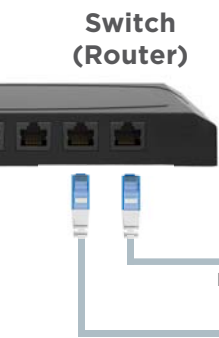

LAN

Energy Gateway RFPM-2M

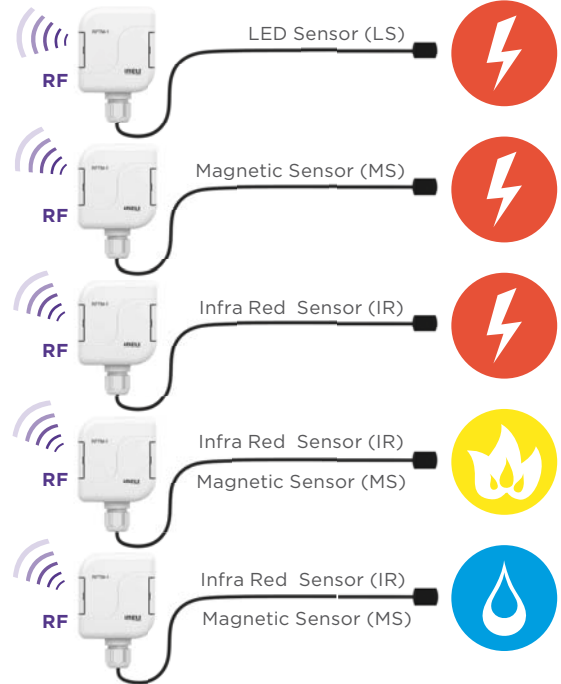
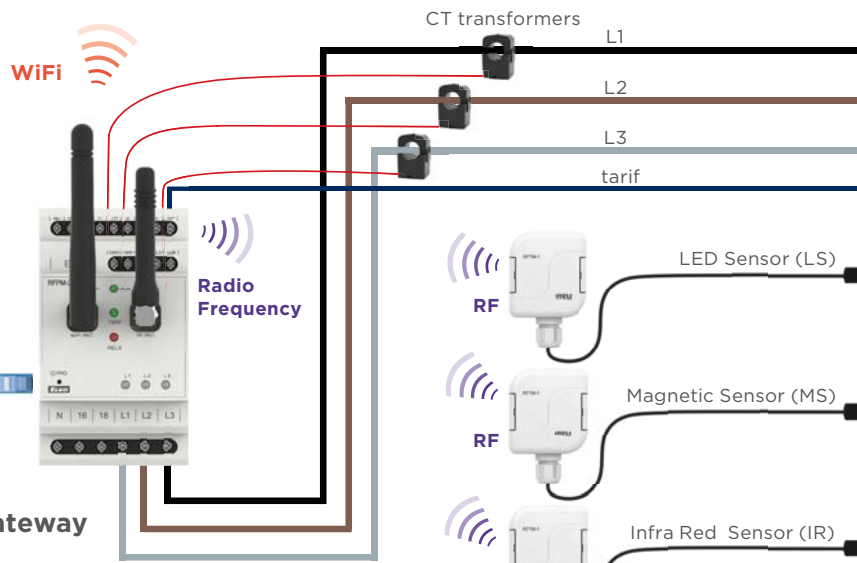

... up to 8 outputs



PHONE
+ 420 800 100 671



E-MAIL
export@elkoep.com



www.elkoep.com
www.inels.com

Wired solution (BUS)

The bus solution is used for large buildings, commercial space and apartment buildings with a large number of meters (up to 140). These meters must be equipped with a pulse output, which is connected by wire to the input unit (14 inputs). The input units are connected by bus to the central unit CU3. The

central unit is connected by LAN to an iMM Server, which converts measured data to consumption values and consequently then provides such data for display in applications (telephone, tablet, PC, TV).



CU3-02M



IM3-140M

Central unit

- the brain of the entire system iNELS and the „interface“between the user program environment and controllers
- has an OLED display, showing the current status, and enables settings (network settings, date, time, services) central units
- it is possible to connect to it up to two branches of the CIB bus, whereas to each bus, you can connect up to 32 iNELS3 units

Binary inputs modul

- this is designed for connecting up to 14 meters with pulse potential free output
- by CIB bus, by which it is also powered, it is connected in the central unit CU3
- there can be up to 10 output units connected, i.e. 140 meters
- it can be combined with further devices with potential free input (buttons, sensors, detectors, etc.) - e.g. a switch for opening the gas meter door...

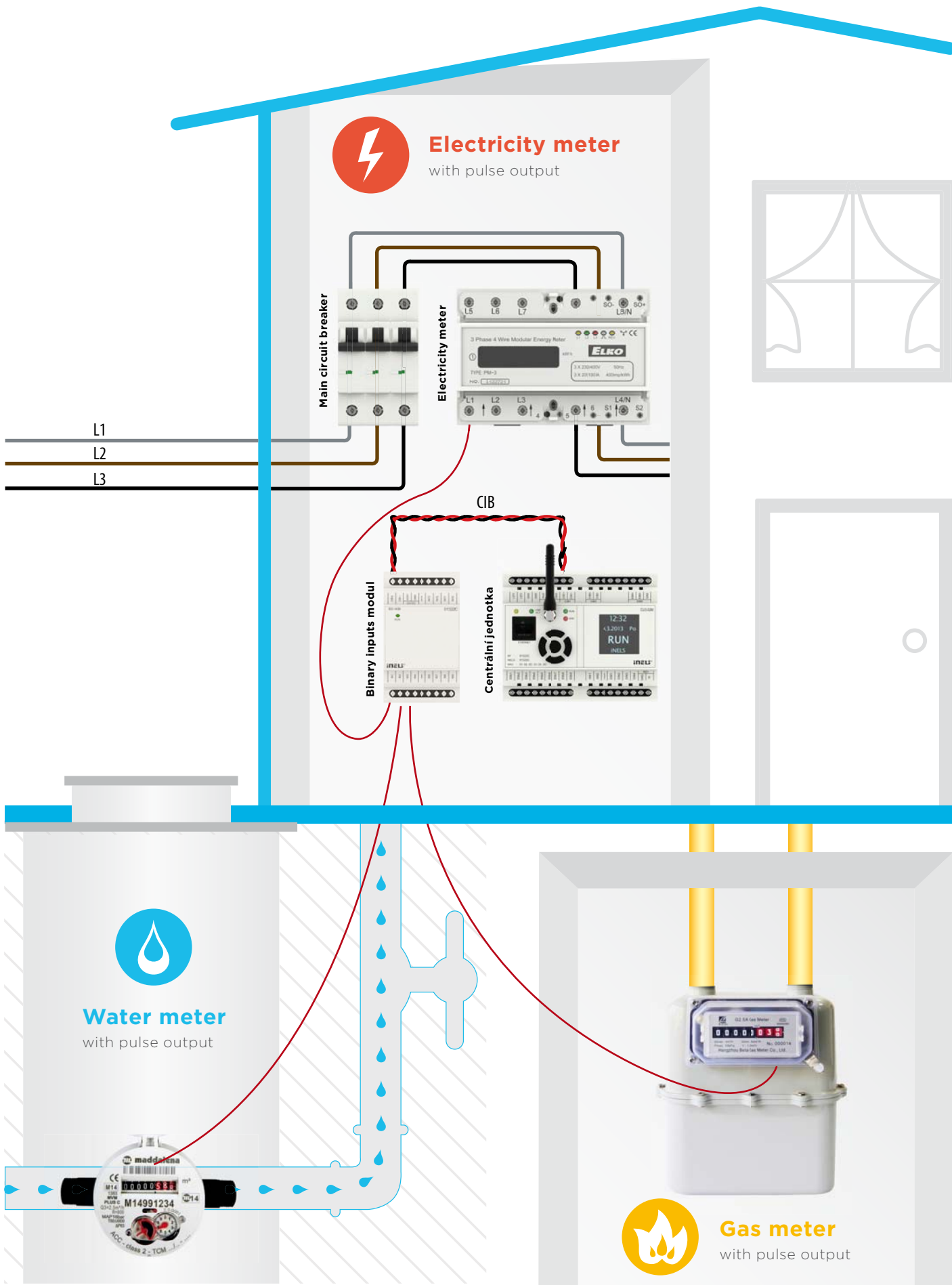

PHONE
+ 420 800 100 671



E-MAIL
export@elkoep.com



www.elkoep.com
www.inels.com

Wireless solution (RF)

The wireless solution is appropriate for existing buildings where metering equipment has already been installed. It is therefore necessary to sense the measured values without interfering in metering equipment) and transfer data to the energy gateway, which processes the data and renders it for assessment. Methods of sensing meters function on the principle

of sensing pulses, flashing of an LED, turning of a dial or a unit wheel. By means of a converter, these pulses are transmitted wirelessly to the energy gateway, which provides them with information for visualization in the application in a smartphone, tablet or stores them on the Cloud.



RFBM-2M



RFBM-1

Energy gateway

- energy gateway for data collection from meter sensors and measuring current probes
- interface for displaying on mobile devices and Cloud storage
- 2x inputs for connecting potential free pulse outputs of meters
- 3x inputs for connection current probes (CT50) for indirect electricity measurement
- 2x inputs for potential free contact of the tariff switch (SmartGrid)
- RF antenna for wireless receipt from wireless pulse converters

OUTPUTS AND COMMUNICATION INTERFACES:

- RJ45 connector for connecting to LAN
- WiFi antenna for communicating with Mobile devices
- switching contact 16A with potential L1
- bus for connecting to central unit CU3

Wireless pulse converter

- detects home energy meters (electricity, water, gas) using sensors and sends them to the wireless unit RFBM-2
- the sensor is designed for use on existing meters even without impulse output „SO“
- it senses energy meters by means of **LS** (LED Sensor), **MS** (Magnetic Sensor), **IRS** (Infra Red Sensor) or impulse output
- increased IP protection enables use in outdoor areas
- battery power (1.5V / 2 x AAA) with average battery life of around 2 years (according to amount of transferred information - pulses)

Methods of sensing meters



Electricity



Gas



Water

CT (Current transformer)

Opening pliers open/close on the existing wire of the measured circuit, most frequently at the main supply at the electricity meter.

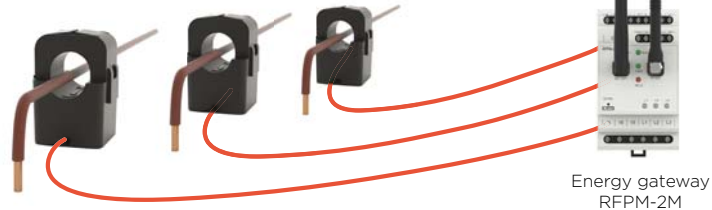

LS (LED sensor)

The LED sensor scans LED impulses on the meter, which indicates consumption by flashing.

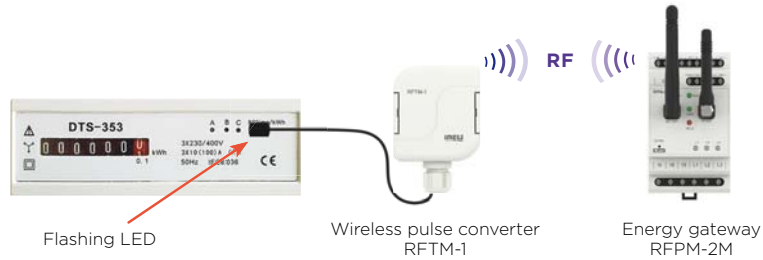

MS (Magnetic sensor)

The magnetic sensor scans movement of the numeral, upon which a permanent magnet is placed.



IRS (Infra Red sensor)

The IR sensor senses the reflective curtain placed on the moving number of the meter or senses the rotating indicator (mainly on water meters).



IMP (Output „S0“)

Meters with impulse output indicated as „S0“ connected by wires to terminals GND and DATA1 on the sensor RFTM-1.



Visit our stand 2 B05

ELKO EP Holding, SE,
Holesov-Vsetuly, Czech republic



Facts and Stats

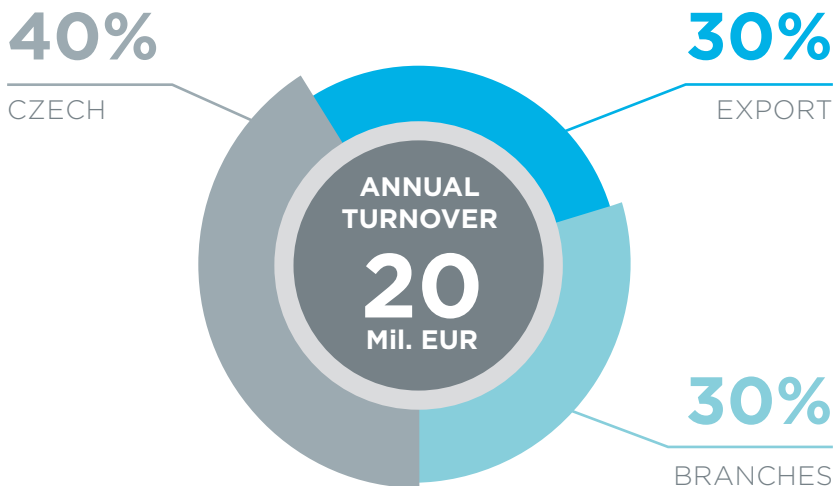

10
BRANCHES
OVER THE WORLD



70
EXPORTING
COUNTRIES

300
EMPLOYEES

5 000
INELS INSTALLATION

12 000 000
MANUFACTURED PRODUCTS

Marketing support



Smart Home & Building Guide



LARA... Medioplayer in the switch



iNELS for everything, everywhere



We brighten up your impressions



Wireless Electro-installations



Wired Electro-installations



PHONE
+ 420 800 100 671



E-MAIL
export@elkoep.com



www.elkoep.com
www.inels.com

Others just resell



Enjoy watching the entire manufacturing process, from developing the product to its expedition in this video.



However, we develop and manufacture products ourselves!

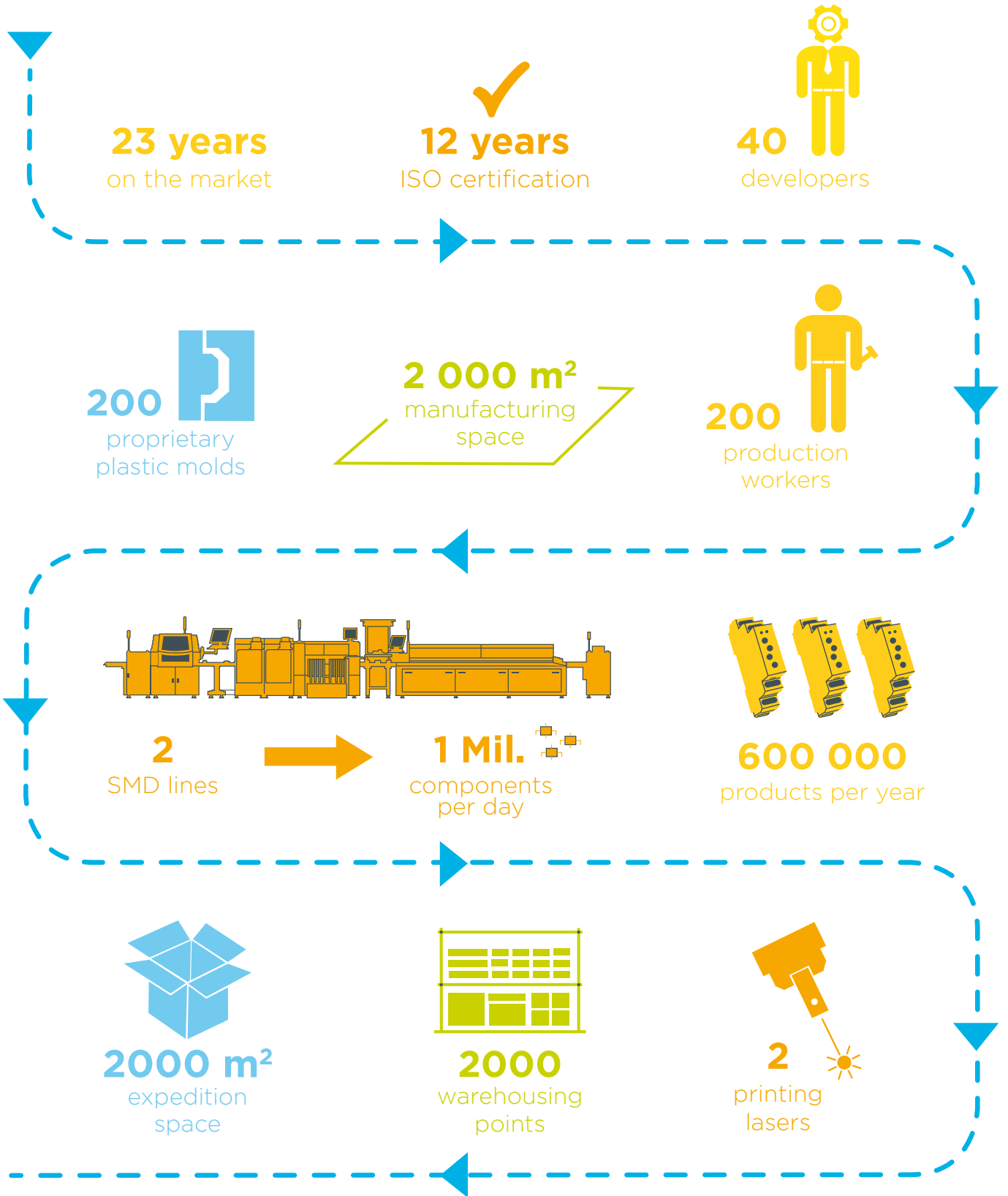

PHONE
+ 420 800 100 671



E-MAIL
export@elkoep.com



www.elkoep.com
www.inels.com